



UNIVERGE BLUE[®]
CONNECT

Quick Start Guide

Yealink W60P Wireless DECT Phone



**ALBURY TELEPHONE
SYSTEMS**

02 6041 2255 www.ats.net.au

Welcome to ATS Cloud Services

What's in the box?

Yealink W60 Wireless DECT Phone

W60B Base Parts

- A. 1 Base Station
- B. 1 Base Stand

- C. 1 Power Adapter
- D. 1 Ethernet Cable

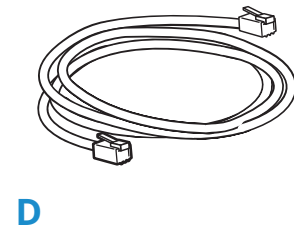
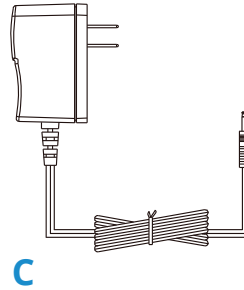
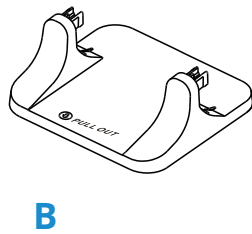
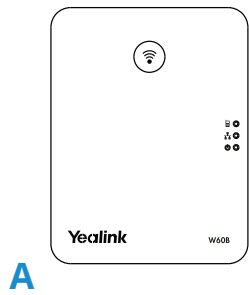

W56H Handset Parts

- A. 1 Handset
- B. 1 USB Charge Cradle

- C. 1 Power Adapter
- D. 1 Rechargeable Battery
- E. 1 Belt Clip

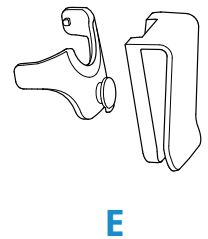
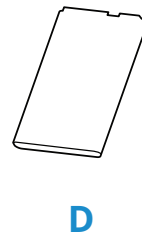
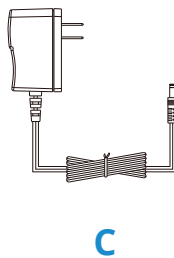
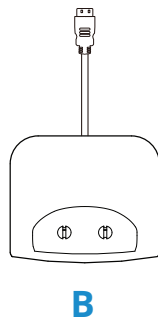

Guided Setup

Connect Cables

Please follow the diagram to install your phones. Once plugged in, the phone will automatically download its configuration and start to work after a few minutes.

Connecting the Cordless Base:

1. Open the box and remove the Cordless Base, Power Adapter and Ethernet cable.
2. Connect one end of the Ethernet cable to the Internet port on the rear of the Base Station.
3. Connect the other end of the Ethernet cable to any free port on your existing router or anywhere on your existing data network.
4. Connect the Base Station Power Adapter to the connector on the Base Station, and then plug the Power Adapter into a power outlet.

a. AC Power Option

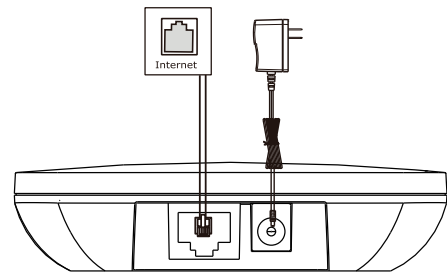

b. PoE (Power over Ethernet) Option

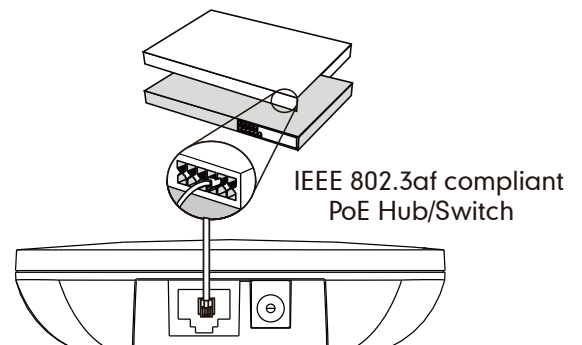

Attach the Base Stand

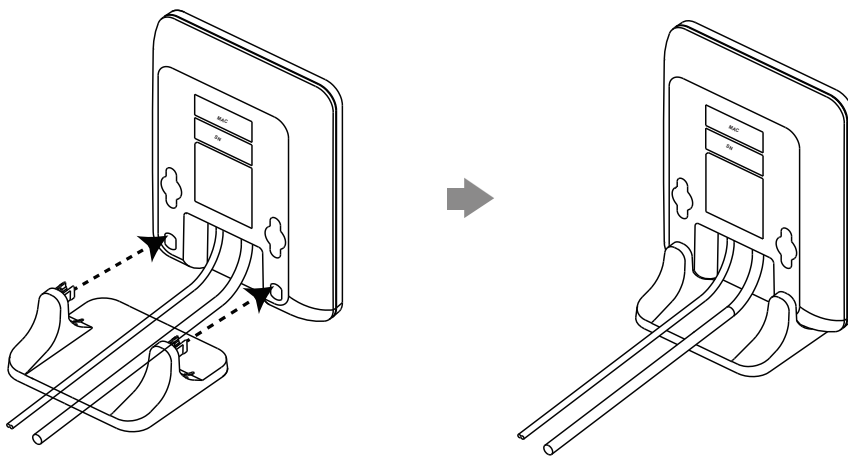

Align the snap-fits with the corresponding holes and push forward, snapping them into the holes.

Guided Setup

Connect Cables (cont.)

Setting up the Cordless Handsets:

1. Open the box and remove the Handset, Power Adapter, Batteries, Belt Clip and Charging Cradle.
2. On the Handset, open the battery cover and insert the battery correctly, then close the battery cover.
3. Connect the Charging Cradle Power Adapter into a power outlet.
4. Connect the optional Belt Clip to the Handset if desired.
5. Place the Handset into the Charging Cradle.

For optimal battery performance, please charge the phone for 6 hours before using.

Once the phone has been plugged in and operational, the voicemail box is functional with a default greeting.

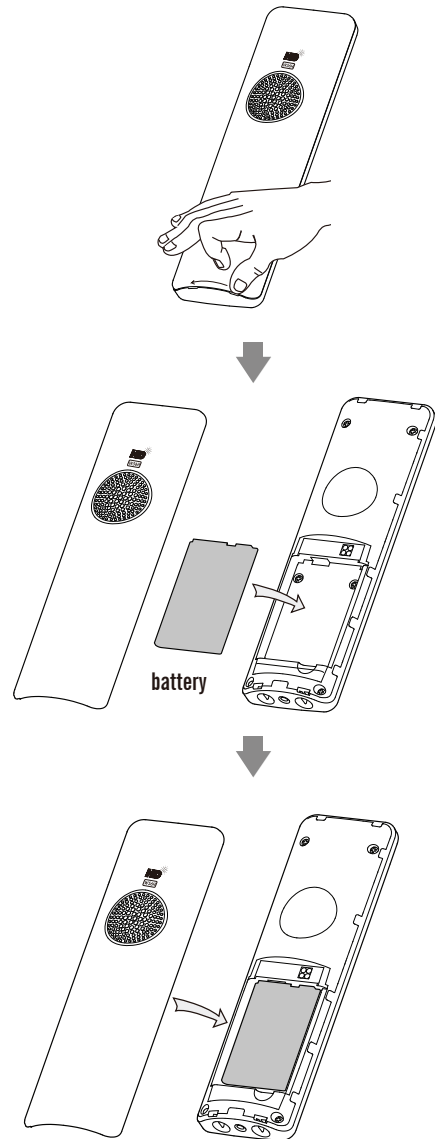

Connect the charger cradle and charge the handset.

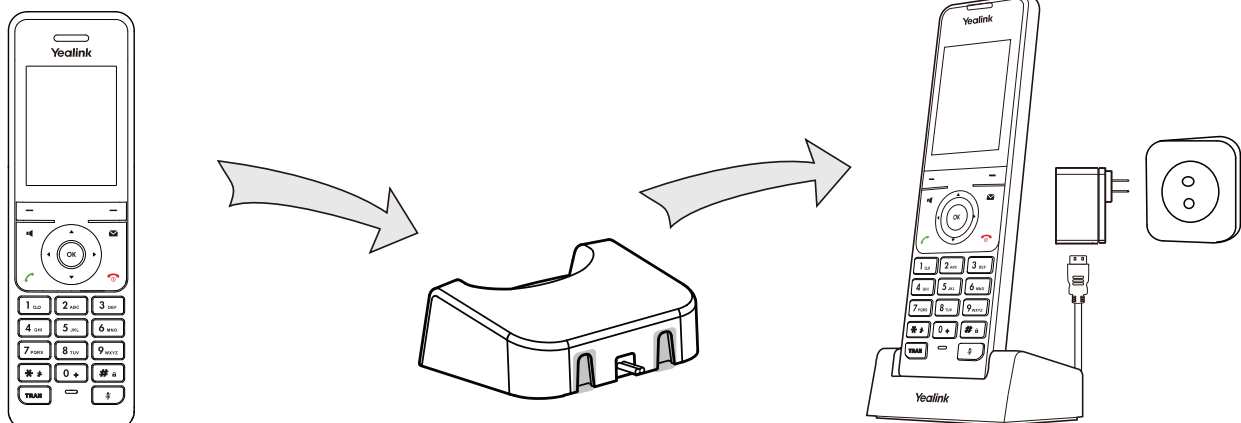

Handset Registration

Important initial setup information:

Your new Handsets are not yet registered with a Base. It is critically important that the Handsets assigned to the W60B Base in HostPilot are in the same order that Handsets are registered to the Base. Once registered with the base, Handsets occupy a 'Handset Position' between 1 and 8 and the 'Handset Position' is mapped to the Handset's serial number. Following a specific setup procedure will ensure that the expected User, phone number and extension will be displayed on the correct Handset.

Please see the Knowledge Base article at: <https://kb.intermedia.net/Article/38762>

Voicemail Box Setup

RECORDING YOUR PERSONAL VOICEMAIL GREETING

1. Press the “Messages”  button.
2. Enter the PIN provided to you by your Administrator, followed by the # key.
3. Select option 3 for personal options.
4. Select option 1 to record your voicemail greeting.
5. Follow the voice prompts to record and check your greeting.

CHANGING THE PIN FROM THE PHONE

1. Press the “Messages”  button.
2. Enter the PIN provided to you by your Administrator, followed by the # key.
3. Select option 3 for personal options.
4. Select option 2 to change your PIN.
5. Enter the new PIN when prompted. Press # when done.

Features

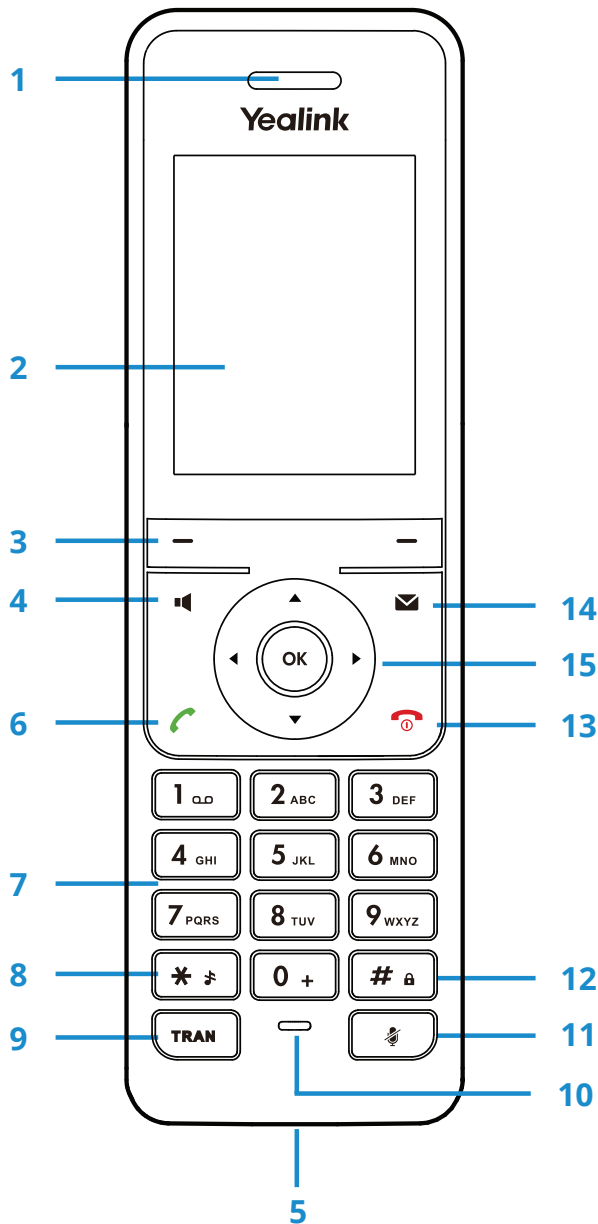

1. **Earpiece**
Outputs audio during a phone call.
2. **LCD Screen**
Shows call information, handset status icons, prompt messages, etc.
3. **Soft Keys**
Labeled automatically to identify their context-sensitive features.
4. **Speakerphone Key**
Switches between the earpiece and speakerphone modes.
Answers an incoming call.
5. **Headset Connector**
Connects a headset.
6. **Off-hook Key**
Answers an incoming call. Enters the redial call list. Places a call.
7. **Keypad**
Provides digits, letters and special characters in context-sensitive applications.
8. **Star Key**
Enters the star symbol. Switches the silent mode on or off.

9. **Redirect Key**
Transfers a call to another party.
10. **Microphone**
Picks up audio during earpiece and hands-free calls.
11. **Mute Key**
Toggles Mute feature on or off.
12. **Pound Key**
Enters the pound symbol. Locks or unlocks the handset keypad. Switches the input method.
13. **On-hook Key/Power key**
Long presses in the menu screen to return to the idle screen. Long presses to turn the handset on or off when the handset is idle. Cancels actions or ends a call. Rejects an incoming call.
14. **Message Key**
Indicates a new received voice mail or a missed call. Accesses the voice mail or the missed call list.

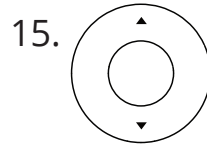

Moves the cursor.
Acts as shortcuts.
Scrolls through the displayed information.

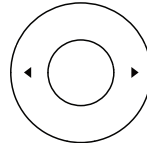

Moves the cursor.
Acts as shortcuts.
Adjusts the ringer volume.
Switches the values.



Confirms actions or enters the main menu.

Displaying Information on the LCD Screen

The idle screen may be shown as below:

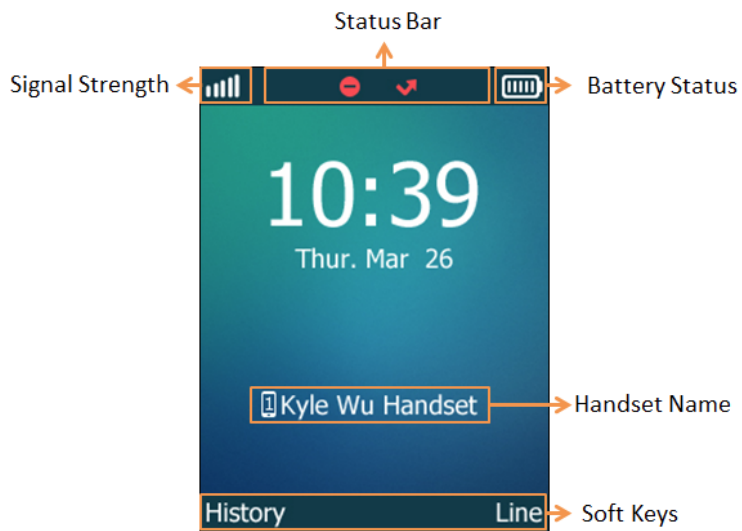

The LCD screen is divided into three parts: Status Line, Text Line and Softkey Line.

THE INFORMATION SHOWN IN THE STATUS LINE:

1. On hook (idle) — displays the signal strength indicator, internal handset number and battery status.
2. Off hook — displays line ID.

THE INFORMATION SHOWN IN THE TEXT LINE:

1. On hook (idle) — displays handset name, time and date, caller information when receiving an incoming call and prompt messages.
2. Off hook — displays the dialed digits.

THE INFORMATION SHOWN IN THE SOFTKEY LINE:

1. On hook (idle) — displays History and Line.
2. Off hook — displays various options according to the context of the specific feature.

SIGNAL STRENGTH

Weak to strong:



No reception:



BATTERY STATUS

The battery status displays on the top right-hand corner of the LCD screen:

Icon Battery Level

	Full
	High
	Medium
	Low
	Need Charging

ICON INSTRUCTIONS

Icons appearing on the LCD screen are described in the following table:

	Received Call
	Placed Call
	Missed Call
	Voice Mail
	Keypad Lock
	Silent Mode
	Do Not Disturb
	Call Forward
	Call Hold
	Call Mute
	Unassigned Outgoing Line
	Loudspeaker On
	Headset Mode On
	Anonymous Call Allowed
	Anonymous Call Rejection

Commonly Used Features

PLACING OUTGOING CALLS

When the phone is not in use:

1. Pick the Handset up from the Charging Cradle.
2. Dial an extension number or telephone number.
3. Press the green Call button.

When you are already on a call:

1. Press the Options softkey and use the down arrow to select Hold and press Ok.
 - This will place the first call on hold AND allow you to place a second call
2. Press the Line softkey.
3. Press the Dial softkey.
4. Dial an extension number or telephone number and press the green Call button.
5. To resume the original call, end your second call, and press the Resume softkey.

ANSWERING AN INCOMING CALL

...On a Handset:

Pick up the Handset from the Base Station or press the Accept softkey.

...On a Headset:

Pick up the Handset from the Base Station or press the Accept softkey.

...On Speakerphone:

Pick up the Handset from the Base Station and press the Speaker button.

IGNORING AN INCOMING CALL

Press the "Silence" softkey to send the caller to voicemail.

ENDING A CALL

Press the red End Call button.

HOLD

Placing a Call On Hold:

1. While on a call, press the Options softkey.
2. Use the down arrow to highlight Hold and press the Ok softkey. The call is now on hold.

Retrieving Calls On Hold:

- Press the Resume softkey.

TRANSFERRING CALLS

Blind Transfers:

1. While on a call, press the Options softkey.
2. Select Transfer and press the Ok softkey.
3. Dial an extension number or telephone number and press the Transfer Softkey.
4. The call is automatically transferred.

Attended (Consultative or Warm) Transfers:

1. While on a call, press the Options softkey.
2. Select Transfer and press the Ok softkey.
3. Dial an extension number or telephone number and press the green Call button.
4. When the party answers, announce the call.
5. Press the Transfer softkey.
6. The call is automatically transferred.

MUTE

1. While on a call, press the Mute button on the Handset.
2. To un-mute the call, press the Mute button again.

VOICEMAIL

1. Press and hold the 1 key on the Handset keypad or dial your phone's extension or phone number.
2. Enter your PIN when prompted, followed by #.

VOLUME ADJUSTMENT

In-Call Volume:

- While on a call, press the left or right arrows on the keypad to raise or lower the volume.

Ringer Volume:

- While the phone is not in use, press the left or right arrows on the keypad to raise or lower the ringer volume.

CALL WAITING

When an inbound call rings in, you will hear a beep tone emitted by your phone if it is already in use.

To Answer the Second Call:

1. Press the down arrow button to highlight the new call and press the "Accept" softkey, the original call goes onto Hold.
2. To switch back to the call on Hold, press the "Swap" softkey.

To Reject the Second Call:

- Press the down arrow button to highlight the new call and press the "Reject" softkey, the caller goes to your voicemail box.

SPEAKERPHONE

While the phone is not in use:

- Press the Speakerphone button to activate the speakerphone and get dial tone for an outbound call.

While on a call on the Handset / Headset

- Press the Speakerphone button to continue the current call on the speakerphone.

FORWARDING CALLS

1. Press the OK button on the keypad.
2. Arrow down to "Call Features" and press the "Ok" softkey.
3. Highlight "Call Forward" and press the "Ok" softkey twice.
4. Choose the type of forwarding needed, then press the "Ok" button.
5. Use the left or right arrow to select "Enabled."
6. Arrow down to the "Target" section and enter the forwarding destination number or extension, then press the "Save" softkey.

Always — Forwards all incoming calls.

Busy — Forwards incoming calls when the phone is busy.

No Answer — Forwards incoming calls when the phone is not answered.



We are here to help.



<https://www.ats.net.au/handset-how-to-videos.html>



service@ats.net.au



02 6041 2255



UN-YEALINKTW60P-QS-001

©2021 www.ats.net.au